



Product Manual

Barracuda 7200.7 Plus

ST3200822A

ST3200021A

Barracuda 7200.7

ST3160023A

ST3160021A

ST3120026A

ST3120022A

ST380013A

ST380011A

ST340014A



Product Manual

Barracuda 7200.7 Plus

ST3200822A

ST3200021A

Barracuda 7200.7

ST3160023A

ST3160021A

ST3120026A

ST3120022A

ST380013A

ST380011A

ST340014A

©2003, 2004, 2005 Seagate Technology LLC All rights reserved
Publication number: 100217279, Rev. N
September 2005

Seagate and Seagate Technology are registered trademarks of Seagate Technology LLC. SeaTools, SeaFONE, SeaBOARD, SeaTDD, and the Wave logo are either registered trademarks or trademarks of Seagate Technology LLC. Other product names are registered trademarks or trademarks of their owners.

Seagate reserves the right to change, without notice, product offerings or specifications. No part of this publication may be reproduced in any form without written permission of Seagate Technology LLC.

Contents

1.0	Introduction	1
2.0	Drive specifications	3
2.1	Specification summary table	3
2.2	Formatted capacity	5
2.2.1	LBA mode	5
2.3	Default logical geometry	5
2.4	Physical organization	6
2.5	Recording and interface technology	6
2.6	Physical characteristics	7
2.7	Seek time	7
2.8	Start/stop times	7
2.9	Power specifications	8
2.9.1	Power consumption	8
2.9.2	Conducted noise	10
2.9.3	Voltage tolerance	10
2.9.4	Power-management modes	10
2.10	Environmental specifications	11
2.10.1	Ambient temperature	11
2.10.2	Temperature gradient	11
2.10.3	Humidity	11
2.10.4	Altitude	11
2.10.5	Shock	12
2.10.6	Vibration	12
2.11	Acoustics	12
2.12	Electromagnetic immunity	13
2.13	Reliability	14
2.14	Agency certification	14
2.14.1	Safety certification	14
2.14.2	Electromagnetic compatibility	14
2.14.3	FCC verification	16
2.15	Environmental protection	16
2.16	Corrosive environment	17
3.0	Configuring and mounting the drive	19
3.1	Handling and static discharge precautions	19
3.2	Breather filter hole precautions	20
3.3	Jumper settings	21
3.3.1	Master/slave configuration	21
3.3.2	Cable-select option	21
3.3.3	Alternate capacity jumper	21
3.3.4	Ultra ATA/100 cable	22
3.4	Drive mounting	22
4.0	ATA interface	25
4.1	ATA interface signals and connector pins	25
4.1.1	Supported ATA commands	27
4.1.2	Identify Device command	29
4.1.3	Set Features command	32
4.1.4	S.M.A.R.T. commands	32
5.0	Seagate Technology support services	35

List of Figures

Figure 1.	Typical 5V startup and operation current profile	9
Figure 2.	Typical 12V startup and operation current profile	9
Figure 3.	Breather filter hole location	20
Figure 4.	Master/slave jumper settings	21
Figure 5.	Ultra ATA cable connectors	22
Figure 6.	Mounting dimensions—top, side and end view	23
Figure 7.	I/O pins and supported ATA signals	26

1.0 Introduction

This manual describes the functional, mechanical and interface specifications for the following Seagate® Barracuda® 7200.7 model drives:

Barracuda 7200.7 Plus

- ST3200822A
- ST3200021A

Barracuda 7200.7

- ST3160023A
- ST3160021A
- ST3120026A
- ST3120022A
- ST380013A
- ST380011A
- ST340014A

These drives provide the following key features:

- 7,200-RPM spindle speed
- 2-Mbyte buffer on: ST3200021A, ST3160021A, ST3120022A, ST380011A and ST340014A
- 8-Mbyte buffer on: ST3200822A, ST3160023A, ST3120026A, and ST380013A
- High instantaneous (burst) data transfer rates (up to 100 Mbytes per second) using Ultra DMA mode 5.
- Giant magnetoresistive (GMR) recording heads and EPRML technology, which provide the drives with increased areal density.
- State-of-the-art cache and on-the-fly error-correction algorithms.
- Full-track multiple-sector transfer capability without local processor intervention.
- Quiet operation.
- 350 Gs nonoperating shock.
- SeaTools diagnostic software performs a drive self-test that eliminates unnecessary drive returns.
- The 3D Defense System™, which includes Drive Defense, Data Defense, and Diagnostic Defense, offers the industry's most comprehensive protection for disc drives.
- Support for S.M.A.R.T. drive monitoring and reporting.
- Support for Read Multiple and Write Multiple commands.
- Support for autodetection of master/slave drives that use cable select (CSEL).

2.0 Drive specifications

Unless otherwise noted, all specifications are measured under ambient conditions, at 25°C, and nominal power. For convenience, the phrases *the drive* and *this drive* are used throughout this manual to indicate ST3200822A, ST3200021A, ST3160023A, ST3160021A, ST3120026A, ST3120022A, ST380013A, ST380011A, and ST340014A model drives.

2.1 Specification summary table

The specifications listed in this table are for quick reference. For details on specification measurement or definition, see the appropriate section of this manual.

Drive specification	ST3200822A ST3200021A	ST3160023A ST3160021A	ST3120026A ST3120022A	ST380013A ST380011A	ST340014A
Formatted Gbytes (512 bytes/sector)*	200	160	120	80	40
Guaranteed sectors	390,721,968	312,581,808	234,441,648	156,301,488	78,165,360
Bytes per sector	512				
Default sectors per track	63				
Default read/write heads	16				
Default cylinders	16,383				
Physical read/write heads	4	4	3	2	1
Discs	2	2	2	1	1
Recording density, BPI (bits/inch max)	671,500	595,000	595,000	595,000	595,000
Track density, TPI (tracks/inch max)	98,000	94,600	94,600	94,600	94,600
Areal density, (Gbits/inch ² max)	68.5	56.3	56.3	56.3	56.3
Spindle speed (RPM)	7,200				
Internal data transfer rate OD, (Mbytes/ sec max)	85.4				
Sustained data transfer rate OD (Mbytes/ sec)	58				
I/O data-transfer rate (Mbytes/sec max)	100				
ATA data-transfer modes supported	PIO modes 0–4 Multiword DMA modes 0–2 Ultra DMA modes 0–5				
Cache buffer ST3200021A, ST3160021A, ST3120022A, ST380011A, and ST340014A	2 Mbytes (2,048 kbytes)				
ST3200822A, ST3160023A, ST3120026A, and ST380013A	8 Mbytes (8,192 kbytes)				
Height (mm max)	26.035 mm (1.028 inches)				

Drive specification	ST3200822A ST3200021A	ST3160023A ST3160021A	ST3120026A ST3120022A	ST380013A ST380011A	ST340014A
Width (mm max)	101.6 mm (4.000 inches)				
Length (mm max)	146.99 mm (5.787 inches)				
Weight (typical)	635 grams (1.4 lb.)				
Average latency (msec)	4.16				
Power-on to ready (sec max)	10 sec				
Standby to ready (sec max)	10 sec				
Startup current (typical) 12V (peak)	2.8 amps				
Track-to-track seek time (msec typical)	<1.0 (read), <1.2 (write)				
Average seek, read (msec typical)	8.5				
Average seek, write (msec typical)	9.5				
Seek power (typical)	12.5 watts				
Read/write power (typical)	12.0 watts				
Idle mode (typical)	7.5 watts				
Standby mode	0.9 watts (typical)				
Sleep mode	0.9 watts (typical)				
Voltage tolerance (including noise)	5V ± 5% 12V ± 10%				
Ambient temperature	5° to 55°C (op) -40° to 70°C (nonop)		0° to 60°C (operating) -40° to 70°C (nonoperating)		
Temperature gradient (°C per hour max)	20°C (operating) 30°C (nonoperating)				
Relative humidity	5% to 90% (operating) 5% to 95% (nonoperating)				
Relative humidity gradient	30% per hour max				
Wet bulb temperature (°C max)	33 (operating) 40 (nonoperating)				
Altitude, operating	-60.96 m to 3,048 m (-200 ft. to 10,000+ ft.)				
Altitude, nonoperating (below mean sea level, max)	-60.96 m to 12,192 m (-200 ft. to 40,000+ ft.)				
Shock, operating (Gs max at 2 msec)	63				
Shock, nonoperating (Gs max at 2 msec)	350 Gs				
Vibration, operating	5-22 Hz: Limited displacement 23-350 Hz: 0.5 G acceleration				
Vibration, nonoperating	5-22 Hz: Limited displacement 23-350 Hz: 5.0 Gs				
Drive acoustics, sound power (bels)					
Idle**	<2.5 (typical) 2.7 (max)		<2.2 (typ) 2.6 (max)		
Performance seek	3.4 (typical) 3.7 (max)		3.1 (typ) 3.5 (max)		
Nonrecoverable read errors	1 per 10 ¹⁴ bits read				

Drive specification	ST3200822A ST3200021A	ST3160023A ST3160021A	ST3120026A ST3120022A	ST380013A ST380011A	ST340014A
Mean time between failures (power-on hours)	600,000				
Service life	5 years				
Warranty	To determine the warranty for a specific drive, use a web browser to access the following web page: www.seagate.com/support/service/ From this page, click on the "Verify Your Warranty" link. You will be asked to provide the drive serial number, model number (or part number) and country of purchase. The system will display the warranty information for your drive.				
Contact start-stop cycles (25°C, 40% rel. humidity)	50,000				

*One Gbyte equals one billion bytes when referring to hard drive capacity. Accessible capacity may vary depending on operating environment and formatting.

**During periods of drive idle, some offline activity may occur according to the S.M.A.R.T. specification, which may increase acoustic and power to operational levels.

2.2 Formatted capacity

Model	Formatted capacity*	Guaranteed sectors	Bytes per sector
ST3200822A ST3200021A	200 Gbytes	390,721,968	512
ST3160023A ST3160021A	160 Gbytes	312,581,808	512
ST3120026A ST3120022A	120 Gbytes	234,441,648	512
ST380013A ST380011A	80 Gbytes	156,301,488	512
ST340014A	40 Gbytes	78,165,360	512

*One Gbyte equals one billion bytes when referring to hard drive capacity. Accessible capacity may vary depending on operating environment and formatting.

2.2.1 LBA mode

When addressing these drives in LBA mode, all blocks (sectors) are consecutively numbered from 0 to $n-1$, where n is the number of guaranteed sectors as defined above.

See Section 4.1.2, "Identify Device command" (words 60-61 and 100-103) for additional information about 48-bit addressing support of drives with capacities over 137 Gbytes.

2.3 Default logical geometry

Cylinders	Read/write heads	Sectors per track
16,383	16	63

2.4 Physical organization

Model	Read/write heads	Number of discs
ST3200822A ST3200021A	4	2
ST3160023A ST3160021A	4	2
ST3120026A ST3120022A	3	2
ST380013A ST380011A	2	1
ST340014A	1	1

2.5 Recording and interface technology

Interface	ATA
Recording method	16/17 EPRML
Recording density BPI (bits/inch max)	595,000 (671,500 for ST3200822A and ST3200021A models)
Track density TPI (tracks/inch max)	94,600 (98,000 for ST3200822A and ST3200021A models)
Areal density (Gbits/inch ² max)	56.3 (68.5 for ST3200822A and ST3200021A models)
Spindle speed (RPM) (\pm 0.2%)	7,200
Internal data-transfer rate OD (Mbytes/sec max)	85.4
Sustained data transfer rate OD (Mbytes/sec max)	58
I/O data-transfer rate (Mbytes/sec max)	100 (Ultra DMA mode 5)
Interleave	1:1
Cache buffer	
ST3200021A, ST3160021A, ST3120022A, ST380011A, and ST340014A	2 Mbytes (2,048 kbytes)
ST3200822A, ST3160023A, ST3120026A, and ST380013A	8 Mbytes (8,192 kbytes)

2.6 Physical characteristics

Drive specification	
Maximum height (mm) (inches)	26.035 1.028
Maximum width (mm) (inches)	101.6 4.00
Maximum length (mm) (inches)	146.99 5.787
Typical weight (grams) (pounds)	635 1.4

2.7 Seek time

Seek measurements are taken with nominal power at 25°C ambient temperature. All times are measured using drive diagnostics. The specifications in the table below are defined as follows:

- Track-to-track seek time is an average of all possible single-track seeks in both directions.
- Average seek time is a true statistical random average of at least 5,000 measurements of seeks between random tracks, less overhead.

*Typical seek times (msec)	Read	Write
Track-to-track	<1.0	<1.2
Average	8.5	9.5
Average latency:	4.16	4.16

*Measured in performance mode.

Note. These drives are designed to consistently meet the seek times represented in this manual. Physical seeks, regardless of mode (such as track-to-track and average), are expected to meet or exceed the noted values. However, due to the manner in which these drives are formatted, benchmark tests that include command overhead or measure logical seeks may produce results that vary from these specifications.

2.8 Start/stop times

Power-on to Ready (sec)	10 (max)
Standby to Ready (sec)	10 (max)
Ready to spindle stop (sec)	10 (max)

2.9 Power specifications

The drive receives DC power (+5V or +12V) through a four-pin standard drive power connector.

2.9.1 Power consumption

Power requirements for the drives are listed in the table on page 8. Typical power measurements are based on an average of drives tested, under nominal conditions, using 5.0V and 12.0V input voltage at 25°C ambient temperature.

- **Spinup power**

Spinup power is measured from the time of power-on to the time that the drive spindle reaches operating speed.

- **Seek mode**

During seek mode, the read/write actuator arm moves toward a specific position on the disc surface and does not execute a read or write operation. Servo electronics are active. Seek mode power represents the worst-case power consumption, using only random seeks with read or write latency time. This mode is not typical and is provided for worst-case information.

- **Read/write power and current**

Read/write power is measured with the heads on track, based on a 16-sector write followed by a 32-msec delay, then a 16-sector read followed by a 32-msec delay.

- **Operating power and current**

Operating power is measured using 40 percent random seeks, 40 percent read/write mode (1 write for each 10 reads) and 20 percent drive idle mode.

- **Idle mode power**

Idle mode power is measured with the drive up to speed, with servo electronics active and with the heads in a random track location.

- **Standby mode**

During Standby mode, the drive accepts commands, but the drive is not spinning, and the servo and read/write electronics are in power-down mode.

Power dissipation (watts) Example: ST3160021A, 2-disc	Average (watts, 25° C)	5V typ amps	12V typ amps
Spinup	—	—	2.8 (peak)
Idle	7.5	0.482	0.424
Idle* (with offline activity)	9.3	0.587	0.530
Operating 40% r/w, 40% seek, 20% inop.	12.0	0.638	0.739
Seeking	12.5	0.412	0.870
Standby	0.900	0.144	0.015
Sleep	0.900	0.144	0.015

*During periods of drive idle, some offline activity may occur according to the S.M.A.R.T. specification, which may increase acoustic and power to operational levels.

2.9.1.1 Typical current profile

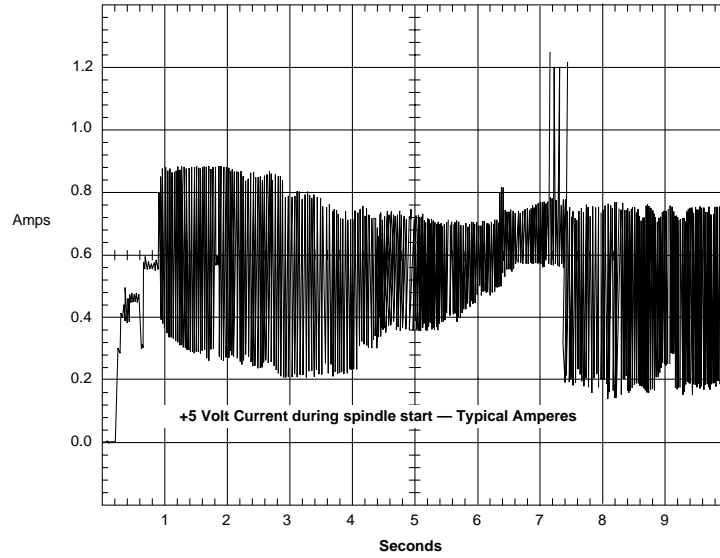

Figure 1. Typical 5V startup and operation current profile

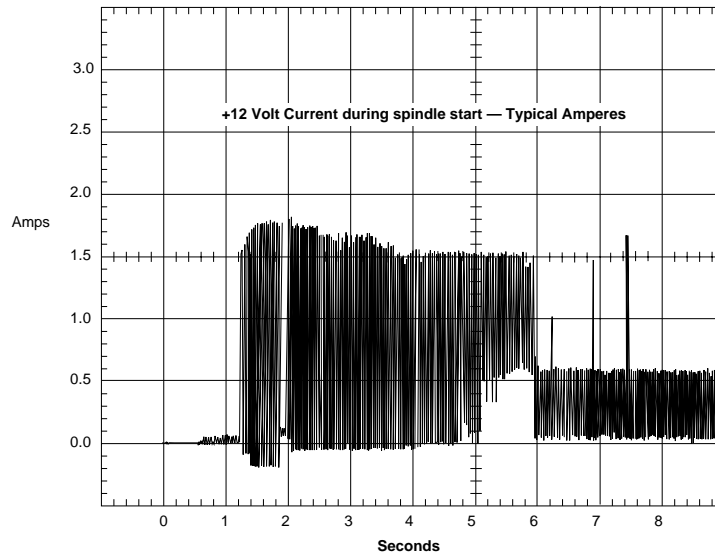

Figure 2. Typical 12V startup and operation current profile

2.9.2 Conducted noise

Input noise ripple is measured at the host system power supply across an equivalent 80-ohm resistive load on the +12 volt line or an equivalent 15-ohm resistive load on the +5 volt line.

- Using 12-volt power, the drive is expected to operate with a maximum of 120 mV peak-to-peak square-wave injected noise at up to 10 MHz.
- Using 5-volt power, the drive is expected to operate with a maximum of 100 mV peak-to-peak square-wave injected noise at up to 10 MHz.

Note. Equivalent resistance is calculated by dividing the nominal voltage by the typical RMS read/write current.

2.9.3 Voltage tolerance

Voltage tolerance (including noise):

5V \pm 5%
12V \pm 10%

2.9.4 Power-management modes

The drive provides programmable power management to provide greater energy efficiency. In most systems, you can control power management through the system setup program. The drive features the following power-management modes:

Power mode	Heads	Spindle	Buffer
Active	Tracking	Rotating	Enabled
Idle	Tracking	Rotating	Enabled
Standby	Parked	Stopped	Enabled
Sleep	Parked	Stopped	Disabled

- **Active mode**

The drive is in Active mode during the read/write and seek operations.

- **Idle mode**

The buffer remains enabled, and the drive accepts all commands and returns to Active mode any time disc access is necessary.

- **Standby mode**

The drive enters Standby mode when the host sends a Standby Immediate command. If the host has set the standby timer, the drive can also enter Standby mode automatically after the drive has been inactive for a specifiable length of time. The standby timer delay is established using a Standby or Idle command. In Standby mode, the drive buffer is enabled, the heads are parked and the spindle is at rest. The drive accepts all commands and returns to Active mode any time disc access is necessary.

- **Sleep mode**

The drive enters Sleep mode after receiving a Sleep command from the host. In Sleep mode, the drive buffer is disabled, the heads are parked and the spindle is at rest. The drive leaves Sleep mode after it receives a Hard Reset or Soft Reset from the host. After receiving a reset, the drive exits Sleep mode and enters Standby mode with all current translation parameters intact.

- **Idle and Standby timers**

Each time the drive performs an Active function (read, write or seek), the standby timer is reinitialized and begins counting down from its specified delay times to zero. If the standby timer reaches zero before any drive

activity is required, the drive makes a transition to Standby mode. In both Idle and Standby mode, the drive accepts all commands and returns to Active mode when disc access is necessary.

2.10 Environmental specifications

2.10.1 Ambient temperature

Ambient temperature is defined as the temperature of the environment immediately surrounding the drive. Actual drive case temperature should not exceed 69°C (156°F) within the operating ambient conditions for standard models, or 64°C (147°F) within the operating ambient conditions for ST3200822A and ST3200021A (PLUS) models.

Above 1,000 feet (305 meters), the maximum temperature is derated linearly to 112°F (44°C) at 10,000 feet (3,048 meters).

Operating	0° to 60°C (32° to 140°F) for standard models 5° to 55°C (41° to 131°F) for ST3200822A and ST3200021A (PLUS) models
Nonoperating	−40° to 70°C (−40° to 158°F)

2.10.2 Temperature gradient

Operating	20°C per hour (68°F per hour max), without condensation
Nonoperating	30°C per hour (86°F per hour max)

2.10.3 Humidity

2.10.3.1 Relative humidity

Operating	5% to 90% noncondensing (30% per hour max)
Nonoperating	5% to 95% noncondensing (30% per hour max)

2.10.3.2 Wet bulb temperature

Operating	33°C (91.4°F max)
Nonoperating	40.0°C (104°F max)

2.10.4 Altitude

Operating	−60.96 m to 3,048 m (−200 ft. to 10,000+ ft.)
Nonoperating	−60.96 m to 12,192 m (−200 ft. to 40,000+ ft.)

2.10.5 Shock

All shock specifications assume that the drive is mounted securely with the input shock applied at the drive mounting screws. Shock may be applied in the X, Y or Z axis.

2.10.5.1 Operating shock

These drives comply with the performance levels specified in this document when subjected to a maximum operating shock of 63 Gs based on half-sine shock pulses of 2 msec. Shocks should not be repeated more than two times per second.

2.10.5.2 Nonoperating shock

The nonoperating shock level that the drive can experience without incurring physical damage or degradation in performance when subsequently put into operation is 350 Gs based on a nonrepetitive half-sine shock pulse of 2 msec duration.

2.10.6 Vibration

All vibration specifications assume that the drive is mounted securely with the input vibration applied at the drive mounting screws. Vibration may be applied in the X, Y or Z axis.

2.10.6.1 Operating vibration

The following table lists the maximum vibration levels that the drive may experience while meeting the performance standards specified in this document.

5–22 Hz	Limited displacement
23–350 Hz	0.5 G acceleration

2.10.6.2 Nonoperating vibration

The following table lists the maximum nonoperating vibration that the drive may experience without incurring physical damage or degradation in performance when subsequently put into operation.

5–22 Hz	Limited displacement
23–350 Hz	5.0 Gs

2.11 Acoustics

Drive acoustics are measured as overall A-weighted acoustic sound power levels (no pure tones). All measurements are consistent with ISO document 7779. Sound power measurements are taken under essentially free-field conditions over a reflecting plane. For all tests, the drive is oriented with the cover facing upward.

Note. For seek mode tests, the drive is placed in seek mode only. The number of seeks per second is defined by the following equation:

$$(\text{Number of seeks per second} = 0.4 / (\text{average latency} + \text{average access time}))$$

Table 1: Fluid Dynamic Bearing (FDB) motor acoustics

Models	Idle*	Performance seek
ST3200822A ST3200021A ST3160023A ST3160021A ST3120026A ST3120022A	<2.5 bels (typ) 2.7 bels (max)	3.4 bels (typ) 3.7 bels (max)
ST380013A ST380011A ST340014A	<2.2 bels (typ) 2.6 bels (max)	3.1 bels (typ) 3.5 bels (max)

*During periods of drive idle, some offline activity may occur according to the S.M.A.R.T. specification, which may increase acoustic and power to operational levels.

2.12 Electromagnetic immunity

When properly installed in a representative host system, the drive operates without errors or degradation in performance when subjected to the radio frequency (RF) environments defined in the following table:

Test	Description	Performance level	Reference standard
Electrostatic discharge	Contact, HCP, VCP: ± 4 kV; Air: ± 8 kV	B	EN 61000-4-2: 95
Radiated RF immunity	80 to 1,000 MHz, 3 V/m, 80% AM with 1 kHz sine 900 MHz, 3 V/m, 50% pulse modulation @ 200 Hz	A	EN 61000-4-3: 96 ENV 50204: 95
Electrical fast transient	± 1 kV on AC mains, ± 0.5 kV on external I/O	B	EN 61000-4-4: 95
Surge immunity	± 1 kV differential, ± 2 kV common, AC mains	B	EN 61000-4-5: 95
Conducted RF immunity	150 kHz to 80 MHz, 3 Vrms, 80% AM with 1 kHz sine	A	EN 61000-4-6: 97
Voltage dips, interrupts	0% open, 5 seconds 0% short, 5 seconds 40%, 0.10 seconds 70%, 0.01 seconds	C C C B	EN 61000-4-11: 94

2.13 Reliability

Nonrecoverable read errors	1 per 10 ¹⁴ bits read, max.
Mean time between failures	600,000 power-on hours (nominal power, 25°C ambient temperature)
Contact start-stop cycles	50,000 cycles (at nominal voltage and temperature, with 60 cycles per hour and a 50% duty cycle)
Service Life	5 years
Warranty	To determine the warranty for a specific drive, use a web browser to access the following web page: www.seagate.com/support/service/ From this page, click on the "Verify Your Warranty" link. You will be asked to provide the drive serial number, model number (or part number) and country of purchase. The system will display the warranty information for your drive.
Preventive maintenance	None required

2.14 Agency certification

2.14.1 Safety certification

The drives are recognized in accordance with UL 1950 and CSA C22.2 (950) and meet all applicable sections of IEC950 and EN 60950 as tested by TUV North America.

2.14.2 Electromagnetic compatibility

Hard drives that display the CE mark comply with the European Union (EU) requirements specified in the Electromagnetic Compatibility Directive (89/336/EEC). Testing is performed to the levels specified by the product standards for Information Technology Equipment (ITE). Emission levels are defined by EN 55022, Class B and the immunity levels are defined by EN 55024.

Seagate uses an independent laboratory to confirm compliance with the EC directives specified in the previous paragraph. Drives are tested in representative end-user systems. Although CE-marked Seagate drives comply with the directives when used in the test systems, we cannot guarantee that all systems will comply with the directives. The drive is designed for operation inside a properly designed enclosure, with properly shielded I/O cable (if necessary) and terminators on all unused I/O ports. Computer manufacturers and system integrators should confirm EMC compliance and provide CE marking for their products.

Korean RRL

If these drives have the Korea Ministry of Information and Communication (MIC) logo, they comply with paragraph 1 of Article 11 of the Electromagnetic Compatibility control Regulation and meet the Electromagnetic Compatibility (EMC) Framework requirements of the Radio Research Laboratory (RRL) Ministry of Information and Communication Republic of Korea.

These drives have been tested and comply with the Electromagnetic Interference/Electromagnetic Susceptibility (EMI/EMS) for Class B products. Drives are tested in a representative, end-user system by a Korean-recognized lab.

- EUT name (model numbers): ST3200822A, ST3200021A, ST3160023A, ST3160021A, ST3120026A, ST3120022A, ST380013A, ST380011A, and ST340014A.
- Certificate numbers:

ST3200822A, ST3200021A	E-H011-03-3949
ST3160023A	E-H011-03-0089
ST3160021A	E-H011-03-0085
ST3120026A	E-H011-03-0086
ST3120022A	E-H011-03-0087
ST380013A	E-H011-03-0088
ST380011A	E-H011-03-0084
ST340014A	E-H011-03-0083
- Trade name or applicant: Seagate Technology
- Manufacturing date: January 2003
(ST3160023A, ST3160021A, ST3120026A, ST3120022A, ST380013A, ST380011A, and ST340014A)
- Manufacturing date: September 2003
(ST3200822A, ST3200021A)
- Manufacturer/nationality: Singapore and China

Australian C-Tick (N176)

If these models have the C-Tick marking, they comply with the Australia/New Zealand Standard AS/NZS3548 1995 and meet the Electromagnetic Compatibility (EMC) Framework requirements of the Australian Communication Authority (ACA).

2.14.3 FCC verification

These drives are intended to be contained solely within a personal computer or similar enclosure (not attached as an external device). As such, each drive is considered to be a subassembly even when it is individually marketed to the customer. As a subassembly, no Federal Communications Commission verification or certification of the device is required.

Seagate Technology LLC has tested this device in enclosures as described above to ensure that the total assembly (enclosure, disc drive, motherboard, power supply, etc.) does comply with the limits for a Class B computing device, pursuant to Subpart J, Part 15 of the FCC rules. Operation with noncertified assemblies is likely to result in interference to radio and television reception.

Radio and television interference. This equipment generates and uses radio frequency energy and if not installed and used in strict accordance with the manufacturer's instructions, may cause interference to radio and television reception.

This equipment is designed to provide reasonable protection against such interference in a residential installation. However, there is no guarantee that interference will not occur in a particular installation. If this equipment does cause interference to radio or television, which can be determined by turning the equipment on and off, you are encouraged to try one or more of the following corrective measures:

- Reorient the receiving antenna.
- Move the device to one side or the other of the radio or TV.
- Move the device farther away from the radio or TV.
- Plug the computer into a different outlet so that the receiver and computer are on different branch outlets.

If necessary, you should consult your dealer or an experienced radio/television technician for additional suggestions. You may find helpful the following booklet prepared by the Federal Communications Commission: *How to Identify and Resolve Radio-Television Interference Problems*. This booklet is available from the Superintendent of Documents, U.S. Government Printing Office, Washington, DC 20402. Refer to publication number 004-000-00345-4.

2.15 Environmental protection

Seagate designs its products to meet environmental protection requirements worldwide, including regulations restricting certain chemical substances.

European Union Restriction of Hazardous Substances (RoHS)

The European Union Restriction of Hazardous Substances (RoHS) Directive restricts the presence of chemical substances, including Lead (Pb), in electronic products effective July 2006. Although amendments to the European Union's Restriction of Hazardous Substances (RoHS) Directive have not been finalized, to the best of our knowledge the disc drives documented in this publication will comply with the final RoHS Directive requirements.

A number of parts and materials in Seagate products are procured from external suppliers. We rely on the representations of our suppliers regarding the presence of RoHS substances in these parts and materials. Our supplier contracts require compliance with our chemical substance restrictions, and our suppliers document their compliance with our requirements by providing material content declarations for all parts and materials for the disc drives documented in this publication. Current supplier declarations include disclosure of the inclusion of any RoHS-regulated substance in such parts or materials.

Seagate also has internal systems in place to ensure ongoing compliance with the RoHS Directive and all laws and regulations which restrict chemical content in electronic products. These systems include standard operating procedures that ensure that restricted substances are not utilized in our manufacturing operations, laboratory analytical validation testing, and an internal auditing process to ensure that all standard operating procedures are complied with.

2.16 Corrosive environment

Seagate electronic drive components pass accelerated corrosion testing equivalent to 10 years exposure to light industrial environments containing sulfurous gases, chlorine and nitric oxide, classes G and H per ASTM B845. However, this accelerated testing cannot duplicate every potential application environment. Users should use caution exposing any electronic components to uncontrolled chemical pollutants and corrosive chemicals as electronic drive component reliability can be affected by the installation environment. The silver, copper, nickel and gold films used in Seagate products are especially sensitive to the presence of sulfide, chloride, and nitrate contaminants. Sulfur is found to be the most damaging. In addition, electronic components should never be exposed to condensing water on the surface of the printed circuit board assembly (PCBA) or exposed to an ambient relative humidity greater than 95%. Materials used in cabinet fabrication, such as vulcanized rubber, that can outgas corrosive compounds should be minimized or eliminated. The useful life of any electronic equipment may be extended by replacing materials near circuitry with sulfide-free alternatives.

3.0 Configuring and mounting the drive

This section contains the specifications and instructions for configuring and mounting the drive.

3.1 Handling and static discharge precautions

After unpacking, and before installation, the drive may be exposed to potential handling and electrostatic discharge (ESD) hazards. Observe the following standard handling and static-discharge precautions:

Caution:

- The SeaShell™ replaces electrostatic discharge (ESD) bags. The SeaShell package is a shock-ribbed, transparent clamshell enclosure that limits a drive's exposure to ESD and also protects against external shocks and stresses. The design permits attaching cables, software loading and label/barcode scanning without removing the drive from the SeaShell. This minimizes handling damage. Keep the drive in the SeaShell package until you are ready for installation.
- Before handling the drive, put on a grounded wrist strap, or ground yourself frequently by touching the metal chassis of a computer that is plugged into a grounded outlet. Wear a grounded wrist strap throughout the entire installation procedure.
- Handle the drive by its edges or frame *only*.
- The drive is extremely fragile—handle it with care. Do not press down on the drive top cover.
- Always rest the drive on a padded, antistatic surface until you mount it in the computer.
- Do not touch the connector pins or the printed circuit board.
- Do not remove the factory-installed labels from the drive or cover them with additional labels. Removal voids the warranty. Some factory-installed labels contain information needed to service the drive. Other labels are used to seal out dirt and contamination.

3.2 Breather filter hole precautions

This section contains information regarding the precautions which should be taken regarding the breather filter hole in Seagate hard disc drives. Proper precautions should be taken to ensure full functionality and prevent possible damage to the drive.

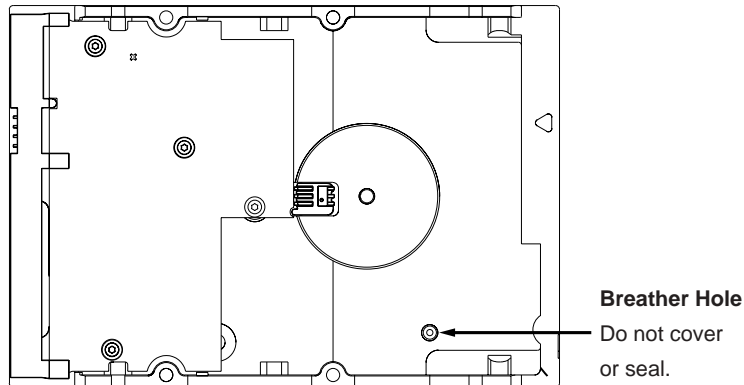

Figure 3. Breather filter hole location

Caution: Do not cover, seal, or insert any object into this hole.

This hole has two purposes:

- To allow condensation inside the hard disc to escape
- To allow air pressure inside the hard disc to equalize with ambient pressure

Note. If this hole is covered, sealed, or penetrated by any object, the drive reliability may be compromised and could lead to permanent damage—doing so voids the warranty.

3.3 Jumper settings

3.3.1 Master/slave configuration

The options jumper block shown in Figure 1 is used to configure the drive for operation. It is the 8-pin dual header between the interface connector and the power connector. Use the following settings to configure the drive as a master or a slave.

Master or single drive. The drive is configured at the factory for a master or single-drive operation with a jumper set on pins 7 and 8.

Drive as slave. Remove all jumpers.

Drive as master with a non-ATA-compatible slave.

Use this jumper setting *only* if the drive does not work as a master with no jumpers installed.

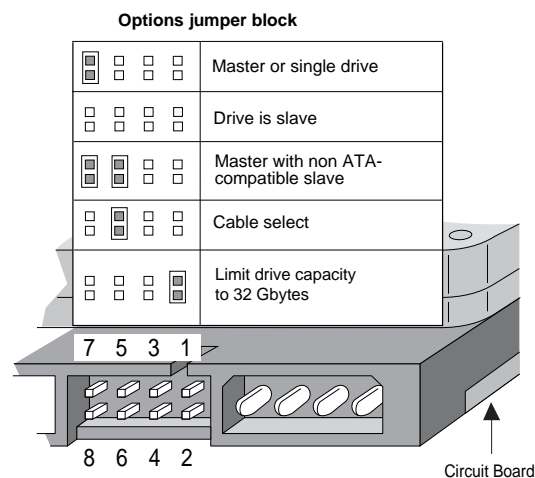

Figure 1. Master/slave jumper settings

3.3.2 Cable-select option

Computers that use cable select determine the master and slave drives by selecting or deselecting pin 28, CSEL, on the interface bus. Master and slave drives are determined by their physical position on the cable. To enable cable select, set a jumper on pins 5 and 6 as shown in Figure 1. Refer to your computer manual to determine whether your computer supports this option.

3.3.3 Alternate capacity jumper

Some older computers may “hang” at startup if their BIOS detects a disc drive with a capacity greater than 32 Gbytes. This limits the drive’s capacity to 32 Gbytes when the alternate capacity jumper is used. To access the full capacity of the drive, you can:

- Update the BIOS
- Use third-party software such as DiscWizard™ or Disk Manager
- Use a third-party host adapter

For drives with capacities greater than 32 Gbytes, the alternate capacity jumper changes the total available LBA sectors to 32 Gbytes to solve issues with some BIOS during power on. The ATA Set Features subcommand “F1_H Report Full Capacity Available” causes Identify Data words 60 and 61 to report the full capacity. See Section 4.1.3 on page 32 for more details on the Set Features command.

Windows XP, Windows Me, Windows 98 or newer versions are needed to support drives with capacities greater than 32 Gbytes.

3.3.4 Ultra ATA/100 cable

An 80-conductor 40-pin cable is required to run Ultra DMA mode 3, mode 4 and mode 5. This cable uses even-numbered conductors connected to the ground pins to improve signal integrity.

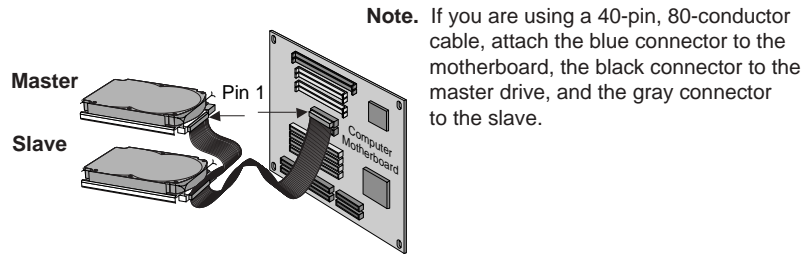

Figure 1. Ultra ATA cable connectors

Note. The drive supports both host and drive cable detection. The host detects the 80-conductor cable by sampling pin 34, CBLID-, on the interface bus. The drive detects the 80-conductor cable by sensing a capacitor at the host side through the CBLID- signal. The result is reported in a Fast Rise Detected bit (bit 13 of word 93 in the Identify drive parameter block).

3.4 Drive mounting

You can mount the drive in any orientation using four screws in the side-mounting holes or four screws in the bottom-mounting holes. See Figure 1 for drive mounting dimensions. Follow these important mounting precautions when mounting the drive:

- Allow a minimum clearance of 0.030 inches (0.76 mm) around the entire perimeter of the drive for cooling.
- Use only 6-32 UNC mounting screws.
- Do not overtighten the mounting screws (maximum torque: 6 inch-lb.).
- Do not use a drive interface cable that is more than 18 inches long.

Notes:

- 1. Dimensions are shown in inches (mm).
- 2. Dimensions per SFF-8301 specification.

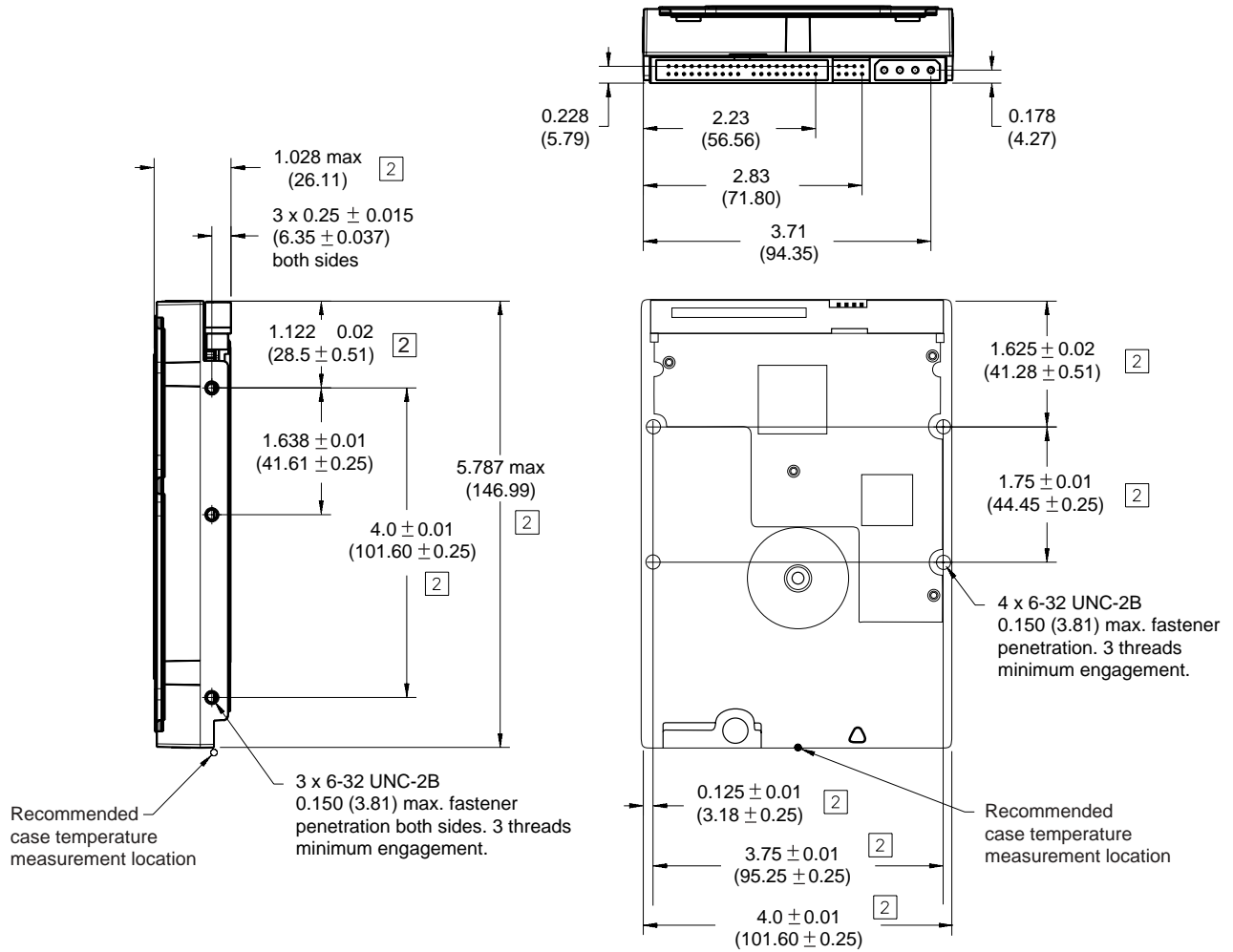

Figure 1. Mounting dimensions—top, side and end view

4.0 ATA interface

These drives use the industry-standard ATA task file interface that supports 16-bit data transfers. It supports ATA programmed input/output (PIO) modes 0–4; multiword DMA modes 0–2, and Ultra DMA modes 0–5. The drive also supports the use of the IORDY signal to provide reliable high-speed data transfers.

You can use a daisy-chain cable to connect two drives to a single AT host bus. For detailed information about the ATA interface, refer to the draft of *AT Attachment with Packet Interface Extension (ATA/ATAPI-6)*, *NCITS T13 1410D*, subsequently referred to as the *Draft ATA-6 Standard*.

4.1 ATA interface signals and connector pins

Figure 1 on page 26 summarizes the signals on the ATA interface connector that the drive supports. For a detailed description of these signals, refer to the *Draft ATA-6 Standard*.

Drive pin #	Signal name	Host pin # and signal description
1	Reset-	1 Hardware Reset
2	Ground	2 Ground
3	DD7	3 Host Data Bus Bit 7
4	DD8	4 Host Data Bus Bit 8
5	DD6	5 Host Data Bus Bit 6
6	DD9	6 Host Data Bus Bit 9
7	DD5	7 Host Data Bus Bit 5
8	DD10	8 Host Data Bus Bit 10
9	DD4	9 Host Data Bus Bit 4
10	DD11	10 Host Data Bus Bit 11
11	DD3	11 Host Data Bus Bit 3
12	DD12	12 Host Data Bus Bit 12
13	DD2	13 Host Data Bus Bit 2
14	DD13	14 Host Data Bus Bit 13
15	DD1	15 Host Data Bus Bit 1
16	DD14	16 Host Data Bus Bit 14
17	DD0	17 Host Data Bus Bit 0
18	DD15	18 Device Data (15:0)
19	Ground	19 Ground
20	(removed)	20 (No Pin)
21	DMARQ	21 DMA Request
22	Ground	22 Ground
23	DIOW-	23 Device I/O Write: Stop Ultra DMA Burst
24	Ground	24 Ground
25	DIOR-	25 Device I/O Read: Host Ultra DMA Ready: Host Ultra DMA Data Strobe
26	Ground	26 Ground
27	IORDY	27 I/O Channel Ready
	DDMARDY-	Device Ultra DMA Ready
	DSTROBE	Device Ultra DMA Data Strobe
28	CSEL	28 Cable Select
29	DMACK-	29 DMA Acknowledge
30	Ground	30 Ground
31	INTRQ	31 Device Interrupt
32	IOCS16-	32 Reserved
33	DA1	33 Host Address Bus Bit 1
34	PDIAG-	34 Passed Diagnostics
	CBLID-	Cable Assembly Type Identifier
35	DA0	35 Device Address (2:0)
36	DA2	36 Device Address (2:0)
37	CS0-	37 Chip Select (1:0)
38	CS1-	38 Chip Select (1:0)
39	DASP-	39 Drive Active/Slave Present
40	Ground	40 Ground

Pins 28, 34 and 39 are used for master-slave communication (details shown below).

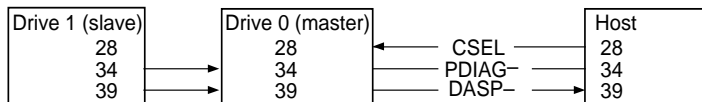

Figure 1. I/O pins and supported ATA signals

4.1.1 Supported ATA commands

The following table lists ATA-standard commands that the drive supports. For a detailed description of the ATA commands, refer to the *Draft ATA-6 Standard*. See “S.M.A.R.T. commands” on page 32 for details and sub-commands used in the S.M.A.R.T. implementation.

Command name	Command code (in hex)
ATA-standard commands	
Download Microcode	92 _H
Execute Device Diagnostics	90 _H
Flush Cache	E7 _H
Flush Cache Extended	EA _H
Identify Device	EC _H
Initialize Device Parameters	91 _H
Read Buffer	E4 _H
Read DMA	C8 _H , C9 _H
Read DMA Extended	25 _H
Read Multiple	C4 _H
Read Multiple Extended	29 _H
Read Native Max Address	F8 _H
Read Native Max Address Extended	27 _H
Read Sectors	20 _H , 21 _H
Read Sectors Extended	24 _H
Read Verify Sectors	40 _H , 41 _H
Read Verify Sectors Extended	42 _H
Seek	70 _H
Set Features	EF _H
Set Max Note: Individual Set Max commands are identified by the value placed in the Set Max Features register as defined to the right.	F9 _H Address: 00 _H Password: 01 _H Lock: 02 _H Unlock: 03 _H Freeze Lock: 04 _H
Set Multiple Mode	C6 _H
S.M.A.R.T.	B0 _H
Write Buffer	E8 _H
Write DMA	CA _H , CB _H
Write DMA Extended	35 _H
Write Multiple	C5 _H
Write Multiple Extended	39 _H
Write Sectors	30 _H , 31 _H

Command name	Command code (in hex)
Write Sectors Extended	34 _H
ATA-standard power-management commands	
Check Power Mode	98 _H or E5 _H
Idle	97 _H or E3 _H
Idle Immediate	95 _H or E1 _H
Sleep	99 _H or E6 _H
Standby	96 _H or E2 _H
Standby Immediate	94 _H or E0 _H
ATA-standard security commands	
Security Set Password	F1 _H
Security Unlock	F2 _H
Security Erase Prepare	F3 _H
Security Erase Unit	F4 _H
Security Freeze Lock	F5 _H
Security Disable Password	F6 _H

4.1.2 Identify Device command

The Identify Device command (command code EC_H) transfers information about the drive to the host following power up. The data is organized as a single 512-byte block of data, whose contents are shown in the table on page 27. All reserved bits or words should be set to zero. Parameters listed with an “x” are drive-specific or vary with the state of the drive. See Section 2.0 on page 3 for default parameter settings.

The following commands contain drive-specific features that may not be included in the *Draft ATA-6 Standard*.

Word	Description	Value
0	Configuration information: • Bit 15: 0 = ATA; 1 = ATAPI • Bit 7: removable media • Bit 6: removable controller • Bit 0: reserved	0C5A _H
1	Number of logical cylinders	16,383
2	ATA-reserved	0000 _H
3	Number of logical heads	16
4	Retired	0000 _H
5	Retired	0000 _H
6	Number of logical sectors per logical track: 63	003F _H
7–9	Retired	0000 _H
10–19	Serial number: (20 ASCII characters, 0000 _H = none)	ASCII
20	Retired	0000 _H
21	Retired	0400 _H
22	Obsolete	0000 _H
23–26	Firmware revision (8 ASCII character string, padded with blanks to end of string)	x.xx
27–46	Drive model number (40 ASCII characters, padded with blanks to end of string)	ST3200822A ST3200021A ST3160023A ST3160021A ST3120026A ST3120022A ST380013A ST380011A ST340014A
47	(Bits 7–0) Maximum sectors per interrupt on Read multiple and Write multiple (16)	8010 _H
48	Reserved	0000 _H
49	Standard Standby timer, IORDY supported and may be disabled	2F00 _H
50	ATA-reserved	0000 _H
51	PIO data-transfer cycle timing mode	0200 _H
52	Retired	0200 _H
53	Words 54–58, 64–70 and 88 are valid	0007 _H
54	Number of current logical cylinders	xxxx _H

Word	Description	Value
55	Number of current logical heads	xxxx _H
56	Number of current logical sectors per logical track	xxxx _H
57–58	Current capacity in sectors	xxxx _H
59	Number of sectors transferred during a Read Multiple or Write Multiple command	xxxx _H
60–61	Total number of user-addressable LBA sectors available (see Section 2.2 for related information) *Note: The maximum value allowed in this field is: 0FFFFFFFh (268,435,455 sectors, 137 Gbytes). Drives with capacities over 137 Gbytes will have 0FFFFFFFh in this field and the actual number of user-addressable LBAs specified in words 100-103. This is required for drives that support the 48-bit addressing feature.	ST3200822A = 0FFFFFFFh* ST3200021A = 0FFFFFFFh* ST3160023A = 0FFFFFFFh* ST3160021A = 0FFFFFFFh* ST3120026A = 234,441,648 ST3120022A = 234,441,648 ST380013A = 156,301,488 ST380011A = 156,301,488 ST340014A = 78,165,360
62	Retired	0000 _H
63	Multiword DMA active and modes supported (see note following this table)	xx07 _H
64	Advanced PIO modes supported (modes 3 and 4 supported)	0003 _H
65	Minimum multiword DMA transfer cycle time per word (120 nsec)	0078 _H
66	Recommended multiword DMA transfer cycle time per word (120 nsec)	0078 _H
67	Minimum PIO cycle time without IORDY flow control (240 nsec)	00F0 _H
68	Minimum PIO cycle time with IORDY flow control (120 nsec)	0078 _H
69–74	ATA-reserved	0000 _H
75	Queue depth	0000 _H
76–79	ATA-reserved	0000 _H
80	Major version number	007E _H
81	Minor version number	0000 _H
82	Command sets supported	346B _H
83	Command sets supported	7D01 _H
84	Command sets support extension	4003 _H
85	Command sets enabled	34xx _H
86	Command sets enabled	3xxx _H
87	Command sets enable extension	4003 _H
88	Ultra DMA support and current mode (see note following this table)	xx3F _H
89	Security erase time	0000 _H
90	Enhanced security erase time	0000 _H
92	Master password revision code	FFFE _H
93	Hardware reset value (see description following this table)	xxxx _H
95–99	ATA-reserved	0000 _H

Word	Description	Value
100–103	Total number of user-addressable LBA sectors available (see Section 2.2 for related information) These words are required for drives that support the 48-bit addressing feature. Maximum value: 0000FFFFFFFFh.	ST3200822A = 390,721,968 ST3200021A = 390,721,968 ST3160023A = 312,581,808 ST3160021A = 312,581,808 ST3120026A = 234,441,648 ST3120022A = 234,441,648 ST380013A = 156,301,488 ST380011A = 156,301,488 ST340014A = 78,165,360
104–127	ATA-reserved	0000 _H
128	Security status	0001 _H
129–159	Seagate-reserved	xxxx _H
160–254	ATA-reserved	0000 _H
255	Integrity word	xxA5 _H

Note. Advanced Power Management (APM) and Automatic Acoustic Management (AAM) features are not supported

Note. See the bit descriptions below for words 63, 88, and 93 of the Identify Drive data:

Description (if bit is set to 1)	
Bit	Word 63
0	Multiword DMA mode 0 is supported.
1	Multiword DMA mode 1 is supported.
2	Multiword DMA mode 2 is supported.
8	Multiword DMA mode 0 is currently active.
9	Multiword DMA mode 1 is currently active.
10	Multiword DMA mode 2 is currently active.
Bit	Word 88
0	Ultra DMA mode 0 is supported.
1	Ultra DMA mode 1 is supported.
2	Ultra DMA mode 2 is supported.
3	Ultra DMA mode 3 is supported.
4	Ultra DMA mode 4 is supported.
8	Ultra DMA mode 0 is currently active.
9	Ultra DMA mode 1 is currently active.
10	Ultra DMA mode 2 is currently active.
11	Ultra DMA mode 3 is currently active.
12	Ultra DMA mode 4 is currently active.
13	Ultra DMA mode 5 is currently active.
Bit	Word 93
13	1 = 80-conductor cable detected, CBLID above V_{IH} 0 = 40-conductor cable detected, CBLID below V_{IL}

4.1.3 Set Features command

This command controls the implementation of various features that the drive supports. When the drive receives this command, it sets BSY, checks the contents of the Features register, clears BSY and generates an interrupt. If the value in the register does not represent a feature that the drive supports, the command is aborted. Power-on default has the read look-ahead and write caching features enabled. The acceptable values for the Features register are defined as follows:

02 _H	Enable write cache (<i>default</i>).
03 _H	Set transfer mode (based on value in Sector Count register). Sector Count register values:
00 _H	Set PIO mode to default (PIO mode 2).
01 _H	Set PIO mode to default and disable IORDY (PIO mode 2).
08 _H	PIO mode 0
09 _H	PIO mode 1
0A _H	PIO mode 2
0B _H	PIO mode 3
0C _H	PIO mode 4 (<i>default</i>)
20 _H	Multword DMA mode 0
21 _H	Multword DMA mode 1
22 _H	Multword DMA mode 2
40 _H	Ultra DMA mode 0
41 _H	Ultra DMA mode 1
42 _H	Ultra DMA mode 2
43 _H	Ultra DMA mode 3
44 _H	Ultra DMA mode 4
45 _H	Ultra DMA mode 5
55 _H	Disable read look-ahead (read cache) feature.
82 _H	Disable write cache.
AA _H	Enable read look-ahead (read cache) feature (<i>default</i>).
F1 _H	Report full capacity available

Note. At power-on, or after a hardware or software reset, the default values of the features are as indicated above.

4.1.4 S.M.A.R.T. commands

S.M.A.R.T. provides near-term failure prediction for disc drives. When S.M.A.R.T. is enabled, the drive monitors predetermined drive attributes that are susceptible to degradation over time. If self-monitoring determines that a failure is likely, S.M.A.R.T. makes a status report available to the host. Not all failures are predictable. S.M.A.R.T. predictability is limited to the attributes the drive can monitor. For more information on S.M.A.R.T. commands and implementation, see the *Draft ATA-6 Standard*.

SeaTools diagnostic software activates a built-in drive self-test (DST S.M.A.R.T. command for D4_H) that eliminates unnecessary drive returns. The diagnostic software ships with all new drives and is also available at: <http://seatools.seagate.com>.

This drive is shipped with S.M.A.R.T. features disabled. You must have a recent BIOS or software package that supports S.M.A.R.T. to enable this feature. The table below shows the S.M.A.R.T. command codes that the drive uses.

Code in features register	S.M.A.R.T. command
D0 _H	S.M.A.R.T. Read Data
D1 _H	Vendor-specific
D2 _H	S.M.A.R.T. Enable/Disable Attribute Autosave
D3 _H	S.M.A.R.T. Save Attribute Values
D4 _H	S.M.A.R.T. Execute Off-line Immediate (runs DST)
D5 _H	S.M.A.R.T. Read Log Sector
D6 _H	S.M.A.R.T. Write Log Sector
D7 _H	Vendor-specific
D8 _H	S.M.A.R.T. Enable Operations
D9 _H	S.M.A.R.T. Disable Operations
DA _H	S.M.A.R.T. Return Status

Note. If an appropriate code is not written to the Features Register, the command is aborted and 0x04 (abort) is written to the Error register.

5.0 Seagate Technology support services

Online services

Internet

www.seagate.com for information about Seagate products and services. Worldwide support is available 24 hours daily by e-mail for your questions.

Presales Support: www.seagate.com/support/email/email_presales.html or Presales@Seagate.com

Technical Support: www.seagate.com/support/email/email_disc_support.html or DiscSupport@Seagate.com

mySeagate

my.seagate.com is the industry's first Web portal designed specifically for OEMs and distributors. It provides self-service access to critical applications, personalized content and the tools that allow our partners to manage their Seagate account functions. Submit pricing requests, orders and returns through a single, password-protected Web interface—anytime, anywhere in the world.

reseller.seagate.com

reseller.seagate.com supports Seagate resellers with product information, program benefits and sales tools. You may register for customized communications that are not available on the web. These communications contain product launch, EOL, pricing, promotions and other channel-related information. To learn more about the benefits or to register, go to reseller.seagate.com, any time, from anywhere in the world.

Automated phone services

SeaFONE® (1-800-SEAGATE) is the Seagate toll-free number (1-800-732-4283) to access our automated directory assistance for Seagate Service Center support options. International callers can reach this service by dialing +1-405-324-4770.

Seagate Service Centers

Presales Support

Our Presales Support staff can help you determine which Seagate products are best suited for your specific application or computer system, as well as drive availability and compatibility.

Technical Support

If you need help installing your drive, consult your system's documentation or contact the dealer's support services department for assistance specific to your system. Seagate technical support is also available to assist you online at support.seagate.com or through one of our call centers. Have your system configuration information and your drive's "ST" model number available.

SeaTDD™ (+1-405-324-3655) is a telecommunications device for the deaf (TDD). You can send questions or comments 24 hours daily and exchange messages with a technical support specialist during normal business hours for the call center in your region.

Customer Service Operations

Warranty Service

Seagate offers worldwide customer support for Seagate drives. Seagate distributors, OEMs and other direct customers should contact their Seagate Customer Service Operations (CSO) representative for warranty-related issues. Resellers or end users of drive products should contact their place of purchase or one of the Seagate CSO warranty centers for assistance. Have your drive's "ST" model number and serial number available.

Data Recovery Services

Seagate offers data recovery services for all formats and all brands of storage media. Our Data Recovery Services labs are currently located in North America. To get a free quick quote or speak with a case management representative, call 1-800-475-0143. Additional information, including an online request form and data loss prevention resources, is available at www.datarecovery.seagate.com.

Authorized Service Centers

In some locations outside the US, you can contact an Authorized Service Center for service.

USA/Canada/Latin America support services

Seagate Service Centers

Presales Support

Call center	Toll-free	Direct dial	FAX
Americas	1-877-271-3285 ¹	+1-405-324-4730 ¹	+1-405-324-4704

Technical Support

Call center	Toll-free	Direct dial	FAX
Americas	1-800-SEAGATE ²	+1-405-324-4700 ²	+1-405-324-3339

Customer Service Operations

Warranty Service

Call center	Toll-free	Direct dial	FAX / E-mail
USA, Canada, Mexico and Latin America	1-800-468-3472 ³	—	+1-956-664-4725
Brazil <i>Jabil Industrial Do Brasil LTDA</i> ⁴	—	+55-11-4191-4761	+55-11-4191-5084 SeagateRMA.br@jabil.com

Data Recovery Services

Call center	Toll-free	Direct dial	FAX
USA, Canada, and Mexico	1-800-475-01435	+1-905-474-2162	1-800-475-0158 +1-905-474-2459

¹Hours of operation are 8:00 A.M. to 11:45 A.M. and 1:00 P.M. to 6:00 P.M., Monday through Friday (Central time).

²Hours of operation are 8:00 A.M. to 8:00 P.M., Monday through Friday (Central time).

³Hours of operation are 8:00 A.M. to 5:00 P.M., Monday through Friday (Central time).

⁴Authorized Service Center

⁵Hours of operation are 8:00 A.M. to 8:00 P.M., Monday through Friday, and 9:00 A.M. to 5:00 P.M., Saturday (Eastern time).

European support services

For presales and technical support in Europe, dial the Seagate Service Center toll-free number for your specific location. If your location is not listed here, dial our presales and technical support call center at +1-405-324-4714 from 8:00 A.M. to 11:45 A.M. and 1:00 P.M. to 5:00 P.M. (Central Europe time) Monday through Friday. The presales and technical support call center is located in Oklahoma City, USA.

For European warranty service, dial the toll-free number for your specific location. If your location is not listed here, dial our European CSO warranty center at +31-20-316-7222 from 8:30 A.M. to 5:00 P.M. (Central Europe time) Monday through Friday. The CSO warranty center is located in Amsterdam, The Netherlands.

Seagate Service Centers

Toll-free support numbers

Call center	Presales and Technical Support	Warranty Service
Austria	—	00 800-47324289
Belgium	00 800-47324283 (00 800-4SEAGATE)	00 800-47324289
Denmark	00 800-47324283	00 800-47324289
France	00 800-47324283	00 800-47324289
Germany	00 800-47324283	00 800-47324289
Ireland	00 800-47324283	00 800-47324289
Italy	00 800-47324283	00 800-47324289
Netherlands	00 800-47324283	00 800-47324289
Norway	00 800-47324283	00 800-47324289
Poland	00 800-311 12 38	00 800-311 12 38
Spain	00 800-47324283	00 800-47324289
Sweden	00 800-47324283	00 800-47324289
Switzerland	00 800-47324283	00 800-47324289
Turkey	00 800-31 92 91 40	00 800-31 92 91 40
United Kingdom	00 800-47324283	00 800-47324289

FAX services—All Europe (toll call)

Technical Support	+1-405-324-3339
Warranty Service	+31-20-653-3513

Africa/Middle East support services

For presales and technical support in Africa and the Middle East, dial our presales and technical support call center at +1-405-324-4714 from 8:00 A.M. to 11:45 A.M. and 1:00 P.M. to 5:00 P.M. (Central Europe time) Monday through Friday. The presales and technical support call center is located in Oklahoma City, USA.

For warranty service in Africa and the Middle East, dial our European CSO warranty center at +31-20-316-7222 from 8:30 A.M. to 5:00 P.M. (Central Europe time) Monday through Friday, or send a FAX to +31-20-653-3513. The CSO warranty center is located in Amsterdam, The Netherlands.

Asia/Pacific support services

For Asia/Pacific presales and technical support, dial the toll-free number for your specific location. The Asia/Pacific toll-free numbers are available from 6:00 A.M. to 10:45 A.M. and 12:00 P.M. to 6:00 P.M. (Australian Eastern time) Monday through Friday, except as noted. If your location is not listed here, direct dial one of our technical support locations.

Warranty service is available from 9:00 A.M. to 6:00 P.M. April through October, and 10:00 A.M. to 7:00 P.M. November through March (Australian Eastern time) Monday through Friday.

Seagate Service Centers

Call center	Toll-free	Direct dial	FAX
Australia	1800-14-7201	—	—
China (Mandarin) ^{1, 4}	800-810-9668	+86-10-6225-5336	—
Hong Kong	800-90-0474	—	—
Hong Kong (Cantonese) ^{1, 4}	001-800-0830-1730	—	—
India ^{2, 4}	1-600-180-1104	—	—
Indonesia	001-803-1-003-2165	—	—
Japan ^{3, 4}	0034 800 400 554	—	—
Korea ^{3, 4}	007 98 8521 7635	—	—
Malaysia	1-800-80-2335	—	—
New Zealand	0800-443988	—	—
Singapore	800-1101-150	—	+65-6488-7525
Taiwan (Mandarin) ^{1, 4}	00-800-0830-1730	—	—
Thailand	001-800-11-0032165	—	—

Customer Service Operations

Warranty Service

Call center	Toll-free	Direct dial	FAX
Asia/Pacific	—	+65-6485-3595	+65-6485-4860
Australia	1800-12-9277	—	—
India ⁴	—	+91-44-821-6164	+91-44-827-2461

¹Hours of operation are 8:30 A.M. to 5:30 P.M., Monday through Friday (Australian Western time).

²Hours of operation are 9:00 A.M. to 6:00 P.M., Monday through Saturday.

³Hours of operation are 9:30 A.M. to 6:30 P.M., Monday through Friday.

⁴Authorized Service Center

Publication feedback survey

We are interested in your comments and suggestions regarding this publication. Please take a few minutes to participate in our survey at the following URL:

<http://survey.seagate.com/survey/techpubs.nsf>

Thank you for your time and comments.

Index

Numerics

3D Defense System 1

A

acoustics 12
Active mode 10
agency certification (regulatory) 14
alternate capacity jumper 21
altitude 11
ambient conditions 3
ambient temperature 7, 11
areal density 1, 6
ATA interface 25
ATA-standard commands 27
Australian C-Tick 15
autodetection 1
average seek time 7

B

BIOS 21
BPI 6
breather filter hole precautions 20
buffer 1, 6
burst 1

C

cable 22
cable select 1
cable-select option 21
cache 1, 6
case temperature 11
CE mark 14
certification 14
Check Power Mode 28
commands 27
compliance 14
conducted noise 10
conducted RF immunity 13
configuring the drive 19
connector pins 25
connectors 22
contact start-stop cycles 14
Corrosive environment 17
CSA C22.2 (950) 14
CSEL 21
C-Tick 15
current profile 9
cycles 14

D

Data Defense 1
data-transfer rates 1
DC power 8
density 6
Diagnostic Defense 1
diagnostic software 1, 33
discs 6
DiscWizard 21
Disk Manager 21
dissipation 8
Download Microcode 27
Drive Defense 1
drive diagnostics 7
drive monitoring 1
drive self-test 1, 33
DST 33

E

electrical fast transient 13
electromagnetic compatibility 14
Electromagnetic Compatibility Directive 14
electromagnetic immunity 13
electrostatic discharge 13
EMC compliance 14
EN 60950 14
enclosures 16
environmental specifications 11
EPRML 1, 6
error-correction algorithms 1
errors 14
European Union 14
Execute Device Diagnostics 27

F

failure prediction 32
FCC verification 16
Features register 32
Flush Cache 27
Flush Cache Extended 27
formatted capacity 5
frequency 13

G

GMR 1
guaranteed sectors 5

H

handling 19
heads 1, 6
height 7
humidity 11

I

- I/O data-transfer rate 6
- Identify Device 27
- Identify Device command 29
- Idle 8, 28
- Idle and Standby timers 10
- Idle Immediate 28
- Idle mode 10
- Idle mode power 8
- IEC950 14
- Information Technology Equipment 14
- Initialize Device Parameters 27
- interface 6, 25
- interface signals 25
- interference 16
- interleave 6
- internal data-transfer rate OD 6
- ISO document 7779 12

J

- jumper settings 21

K

- Korean RRL 15

L

- LBA mode 5
- length 7
- logical geometry 5

M

- maintenance 14
- master 21
- master/slave 1
- Master/slave configuration 21
- maximum temperature 11
- Mean time between failures (MTBF) 14
- modes 25
- monitoring 1
- mounting the drive 19, 22

N

- noise 10
- nominal power 3
- nonoperating shock 12
- nonoperating vibration 12
- nonrecoverable read errors 14

O

- operating 8
- operating power and current 8
- operating shock 12

- operating vibration 12
- orientation 22

P

- physical characteristics 7
- physical organization 6
- pins 25
- PIO 25
- power consumption 8
- power dissipation 8
- power management 10
- power specifications 8
- power-management commands 28
- power-management modes 10
- Power-on to Ready 7
- precautions 22
- preventive maintenance 14
- programmable power management 10

R

- radiated RF immunity 13
- radio and television interference 16
- radio frequency 13
- random track location 8
- Read Buffer 27
- Read DMA 27
- Read DMA Extended 27
- read errors 14
- Read Multiple 1, 27
- Read Multiple Extended 27
- Read Native Max Address 27
- Read Native Max Address Extended 27
- Read Sectors 27
- Read Sectors Extended 27
- Read Verify Sectors 27
- Read Verify Sectors Extended 27
- read/write heads 6
- read/write power and current 8
- recording and interface technology 6
- recording density 6
- recording heads 1
- recording method 6
- register 32
- relative humidity 11
- reliability 14
- resistance 10
- resistive load 10
- RF 13
- RoHS 16

S

- S.M.A.R.T. 27
- S.M.A.R.T. commands 32
- S.M.A.R.T. drive monitoring 1

- safety certification 14
- screws 22
- SeaShell 19
- SeaTools 1, 33
- sectors 5
- security commands 28
- Security Disable Password 28
- Security Erase Prepare 28
- Security Erase Unit 28
- Security Freeze Lock 28
- Security Set Password 28
- Security Unlock 28
- Seek 27
- seek mode 8
- seek time 7
- Seeking 8
- Service Life 14
- servo electronics 8
- Set Features 27
- Set Features command 32
- Set Max 27
- Set Multiple Mode 27
- shock 12
- signals 25
- single-track seeks 7
- slave 21
- Sleep 8, 28
- Sleep mode 10
- sound 12
- specifications 3
- spindle speed 6
- Spinup 8
- spinup power 8
- Standby 8, 28
- Standby Immediate 28
- Standby mode 8, 10
- Standby to Ready 7
- start/stop times 7
- start-stop cycles 14
- static-discharge precautions 19
- stop times 7
- subassembly 16
- support services 35
- surge immunity 13

T

- technical support services 35
- temperature 11
- temperature gradient 11
- timers 10
- track density 6
- track-to-track seek time 7
- TUV North America 14

U

- UL 1950 14
- Ultra ATA/100 22
- Ultra DMA 22

V

- vibration 12
- voltage 10
- voltage dips, interrupts 13
- voltage tolerance 10

W

- weight 7
- wet bulb temperature 11
- width 7
- Write Buffer 27
- Write DMA 27
- Write DMA Extended 27
- Write Multiple 1, 27
- Write Multiple Extended 27
- Write Sectors 27
- Write Sectors Extended 28



Seagate Technology LLC
920 Disc Drive, Scotts Valley, California 95066-4544, USA
Publication Number: 100217279, Rev. N, Printed in USA